

User's Manual

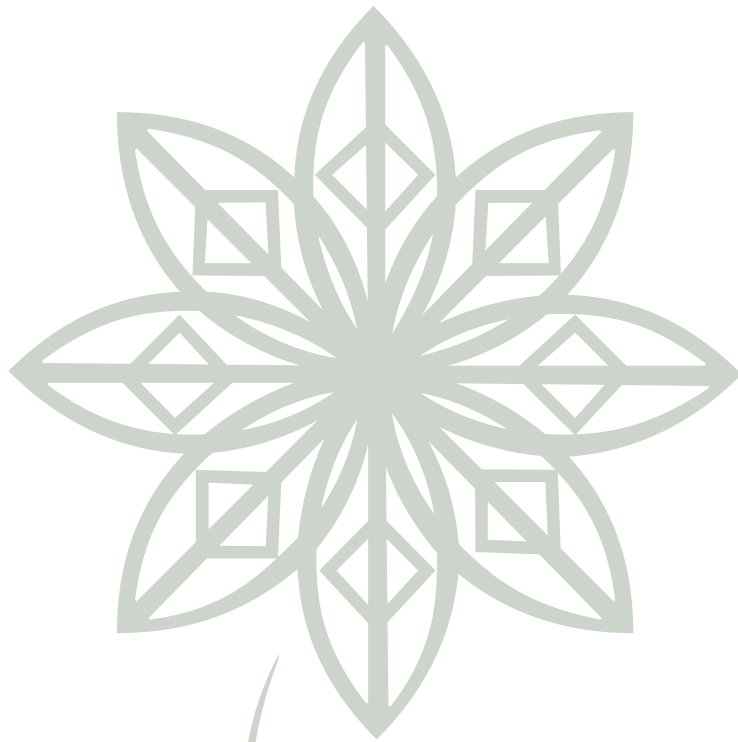

SILHOUETTE™

DIGITAL CRAFT CUTTER

Thank you for purchasing the Silhouette Digital Craft Cutter.

Warning

Only computers or peripherals (computer input/output devices, terminals, printers, etc.) certified as complying with the limits for a Class B digital device, pursuant to Part 15 of the FCC Rules, may be attached to this product when this product is operated in a residential environment. Operation with non-certified peripherals is likely to result in interference to radio and TV.

Federal Communications Commission Radio Frequency Interference Statement

"This equipment has been tested and found to comply with the limits for a Class B digital device pursuant to Part 15 of the FCC Rules. These limits are designed to provide reasonable protection against harmful interference in a residential installation. This equipment generates, uses, and can radiate radio frequency energy and, if not installed and used in accordance with the instructions, may cause harmful interference to radio communications. However, there is no guarantee that interference will not occur in a particular installation. If this equipment does cause harmful interference to radio or television reception, which can be determined by turning the equipment off and on, the user is encouraged to try to correct interference by one or more of the following measures:

- Reorient or relocate the receiving antenna.
- Increase the separation between the equipment and receiver.
- Connect the equipment into an outlet on a circuit different from that to which the receiver is connected.
- Consult the dealer or an experienced radio/TV technician for help."

Notes on this Manual

- (1) No part of this publication may be reproduced, stored in a retrieval system, or transmitted, in any form or by any means, without the prior written permission of Graphtec Corporation.
- (2) The product specifications and other information in this manual are subject to change without notice.
- (3) While every effort has been made to provide complete and accurate information, please contact your sales representative or nearest Graphtec vendor if you find any unclear or erroneous information or wish to make other comments or suggestions.
- (4) Notwithstanding the stipulations in the preceding paragraph, Graphtec Corporation assumes no liability for damages resulting from either the use of the information contained herein or the use of the product.

Registered Trademarks

All names of companies, brands, logotypes, and products appearing in this manual are the trademarks or registered trademarks of their respective companies.

Copyright

This User's Manual is copyrighted by Graphtec Corporation.

CONTENTS

PREFACE

Warning	i
Federal Communications Commission Radio Frequency Interference Statement	i
Notes on this Manual.....	i
Registered Trademarks	i
Copyright	i

CHAPTER 1. PRIOR TO USE

1.1 Check All the Items	1-1
1.2 Craft ROBO Parts and Functions	1-2

CHAPTER 2. CONNECTION AND PREPARATION

2.1 Connecting and Turning on the Power	2-1
2.2 Connecting to a Computer	2-2
2.3 Loading Media	2-3
Media loading method	2-3
Allowable cutting area	2-5
2.4 Carrier Sheet	2-7
Using the carrier sheet	2-7
Allowable cutting area of the carrier sheet	2-9
2.5 Adjusting and Mounting the Blade Holder	2-10
Blade holder construction	2-10
Blade adjustment caps and media selection	2-10
Changing the blade adjustment cap	2-11
Mounting the blade holder	2-12
2.6 Mounting a ballpoint pen	2-13
Acceptable ballpoint pens	2-13
Mounting the ballpoint pen	2-14
2.7 What to Do if This Happens	2-15

CHAPTER 3. CRAFT ROBO CONTROLLER

3.1 System Requirements	3-1
3.2 Installing the Craft ROBO Controller	3-2
Starting up the [Start] window	3-2
Installing the Craft ROBO Controller	3-2
3.3 Starting up the Craft ROBO Controller	3-4
3.4 Craft ROBO Controller Operations	3-6
Cutting your design	3-6
Printing your design on a printer, and then using the Craft ROBO to cut it	3-6
Test Plotting	3-7
Performing a test cut and creating a Media Type setting	3-8
3.5 Craft ROBO Controller Settings	3-9
3.6 Error Messages	3-18

APPENDIX

Appendix A. Standard Specifications	A-1
---	-----

INDEX	I-1
-------------	-----

CHAPTER 1. PRIOR TO USE

1.1 Check All the Items

Referring to the list below, check to confirm that all the components are included with your product. If any item is missing, please contact your place of purchase.

AC adapter, Power cable1 set

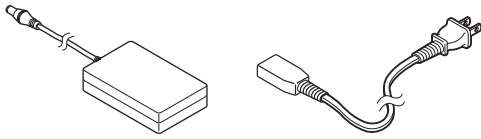

USB cable1

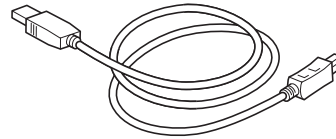

Craft ROBO Software CD-ROM1

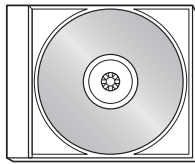

Quick Start Instructions1

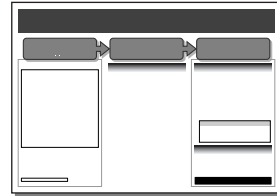

Quick Application Guide1



Carrier sheet1

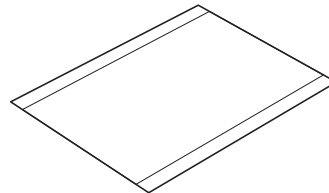

Blade holder (with blade adjustment caps)1 set

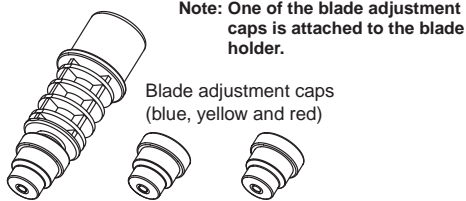

Ballpoint pen holder1

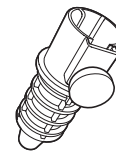

Media Trial Kit1

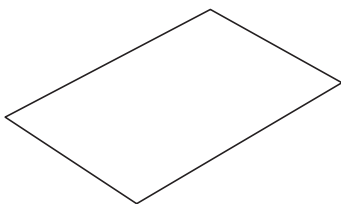

1.2 Craft ROBO Parts and Functions

Craft ROBO (CC200)

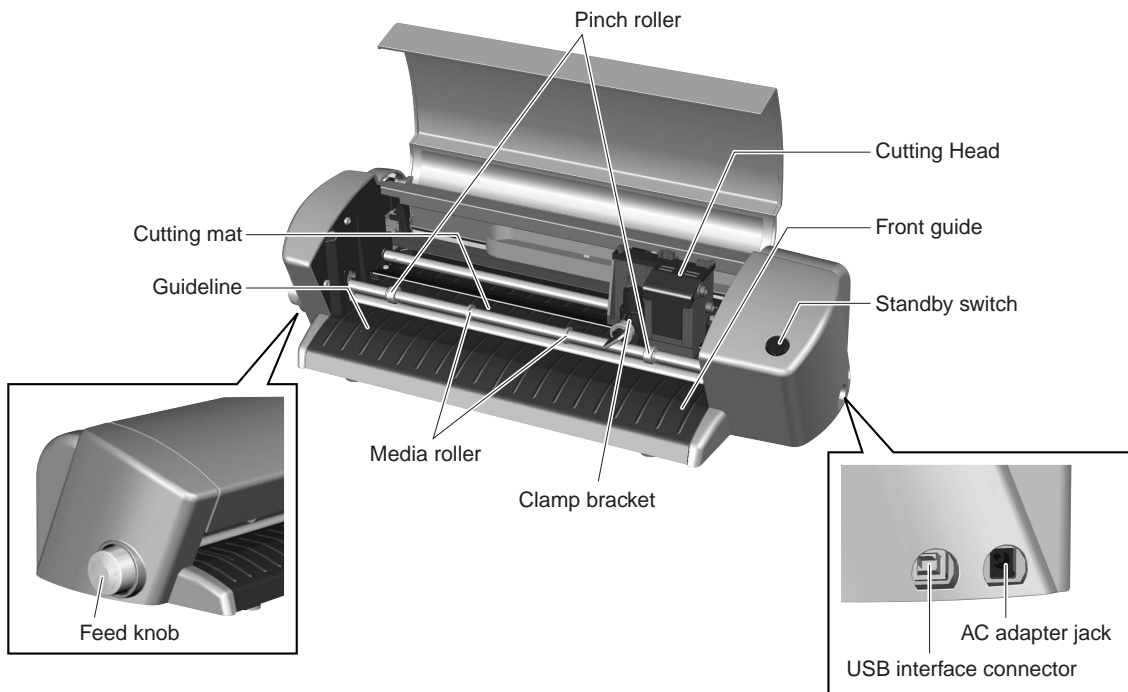

- Cutting head** Drives the blade holder/pen holder to the left or right
- Clamp bracket** Holds the blade holder/pen holder and drives it up or down
- Standby switch** Turns the power supply to the Craft ROBO on and off. When the power supply is on, the switch's lamp lights blue.
- Feed knob** Used to manually feed the media back and forth
- USB interface connector**
..... Used for connecting the USB cable
- AC adapter jack** Used for connecting the AC adapter cable
- Cutting mat** Cutting or plotting is performed on this surface
- Pinch rollers** Hold the media in place against the media rollers
- Media rollers** Move the media back and forth
- Front guide** Used as the work surface
- Guideline** Used as a guide when media is loaded

CHAPTER 2. CONNECTION AND PREPARATION

2.1 Connecting and Turning on the Power

Use the AC adapter and the power cable provided with the Craft ROBO to connect the AC adapter jack on the Craft ROBO to an AC outlet of the rated voltage, and then turn on the power.

CHECKPOINT Always connect the AC adapter to the AC adapter jack before connecting the power cable to the AC outlet.

- (1) Connect the power cable (included with the AC adapter) to the AC adapter.
- (2) Plug the AC adapter cable into the AC adapter jack of the Craft ROBO.
- (3) Plug the other end of the power cable into the AC outlet.

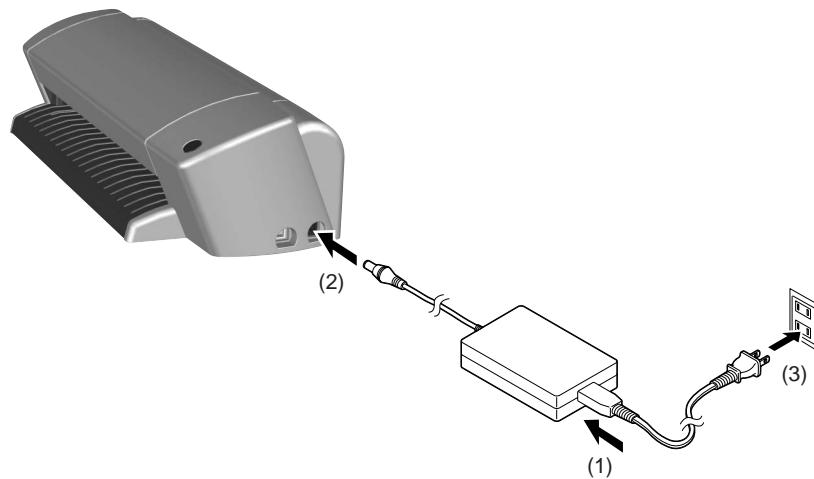

- (4) Press the standby switch to turn on the power.
When the Craft ROBO is in power-on status, the lamp on the switch is lit blue.
When the Craft ROBO is in power-off status, the lamp on the switch is extinguished.



2.2 Connecting to a Computer

The USB interface connectors are used to connect the Craft ROBO to a computer. Use the USB cable provided with the Craft ROBO to connect the Craft ROBO to a computer.

CHECKPOINT

- The software for the Craft ROBO must be installed before the Craft ROBO is connected to a computer. (See Chapter 3.3, "Installing the Craft ROBO Controller".)
- Do not connect the USB cable until instructed to do by an on-screen prompt.

The USB cable has different plug shapes on the computer side and the Craft ROBO side. Always check which plug connects to which side.

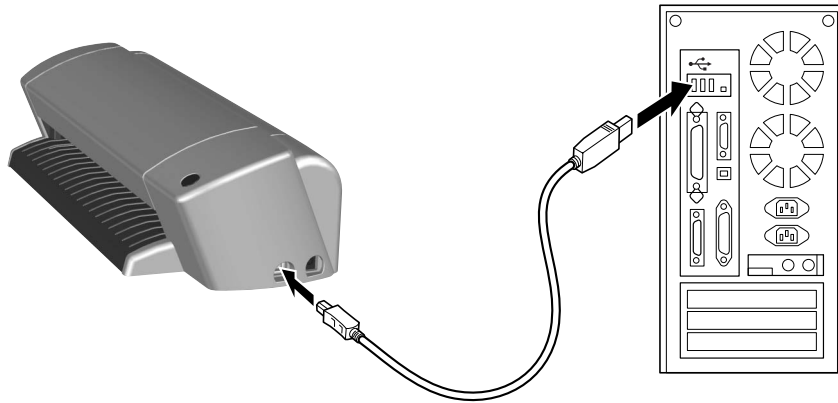

CHECKPOINT

- Do not connect two or more Craft ROBO units to one computer.
- Do not connect the Craft ROBO and a Graphtec plotter to a computer at the same time. If you do so, the Craft ROBO may not operate properly.

2.3 Loading Media

Media loading method

- (1) Press the standby switch to turn on the power, and confirm that the lamp on the standby switch is lit (blue).



- (2) Load the sheet in the Craft ROBO.
Align the left edge of the sheet with the vertical guideline indented on the front guide. Place the top edge of the sheet against both pinch rollers, making sure that the sheet is straight.

CHECKPOINT

If a sheet wider than 8.5 inch is loaded, the guideline will be covered by the sheet. However, if the sheet is loaded so that its top edge touches and is parallel to both the pinch rollers, it will be straight.

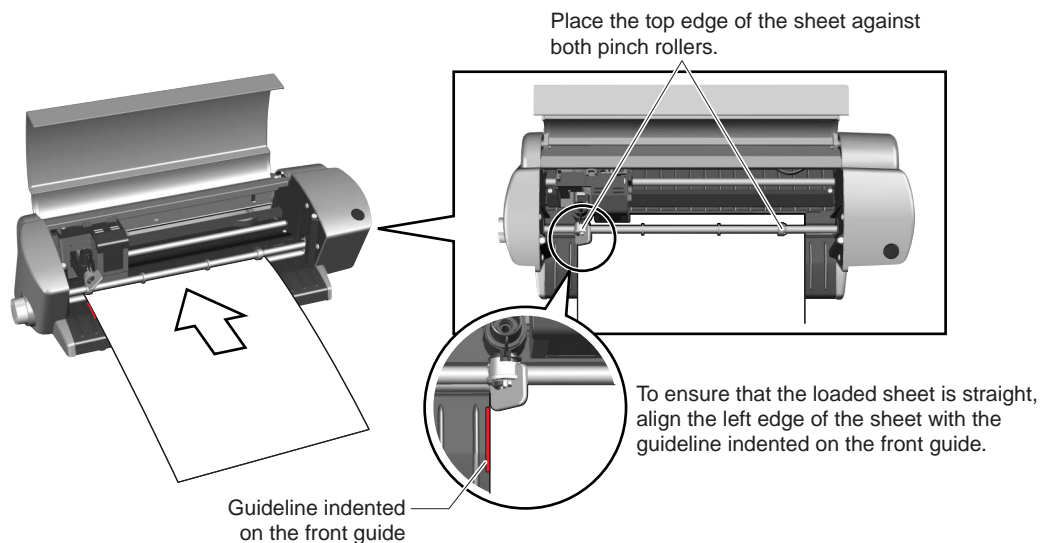

If you are using media that is not letter size, please follow the instructions given below.

- **If the media size is smaller than letter size**

Use the carrier sheet. (Please see Section 2.4, "Carrier Sheet".)

- **If the media width is between 8.5 and 10.25 inch**

If the width of the sheet is between 8.5 and 10.25 inch, the only types of media that can be loaded are vinyl film or tack paper.

- **If the media length is between 11 and 39 inch)**

The accuracy specification is guaranteed for sheets that measure 8.5 x 11 inch, but if the media is film (with a thickness of 0.0039 inch or less, and 0.012 inch or less including the backing sheet (liner)), lengths up to 39 inch can be loaded.

- (3) Turn the feed knob in the direction toward the rear of the Craft ROBO to feed the sheet until its top edge is aligned with the rear edge of the cutting mat, or with the indented guideline located next to the cutting mat.

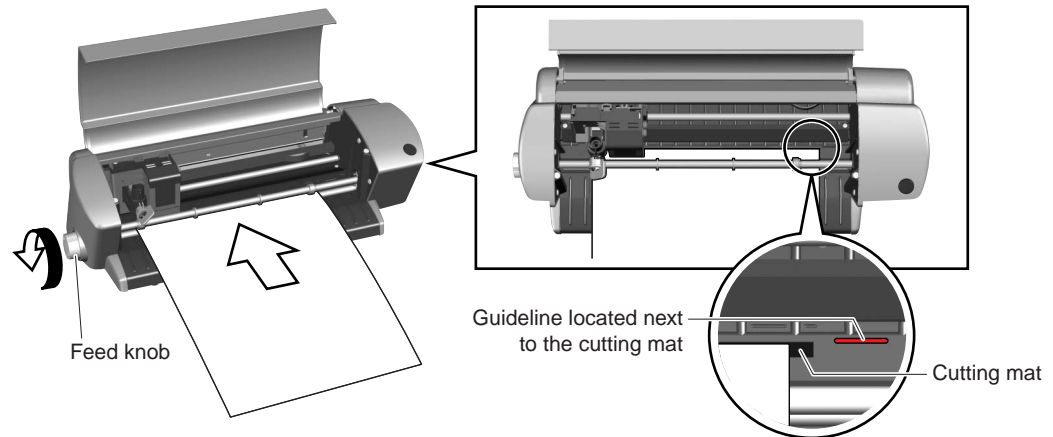

If the top edge of the sheet curls up and catches on the Craft ROBO, turn the feed knob in the direction toward the rear of the Craft ROBO to align the top edge of the sheet with the indented guidelines located behind the cutting mat. Please note, however, that the cutting area will be reduced by 0.2 inch in the media feed direction.

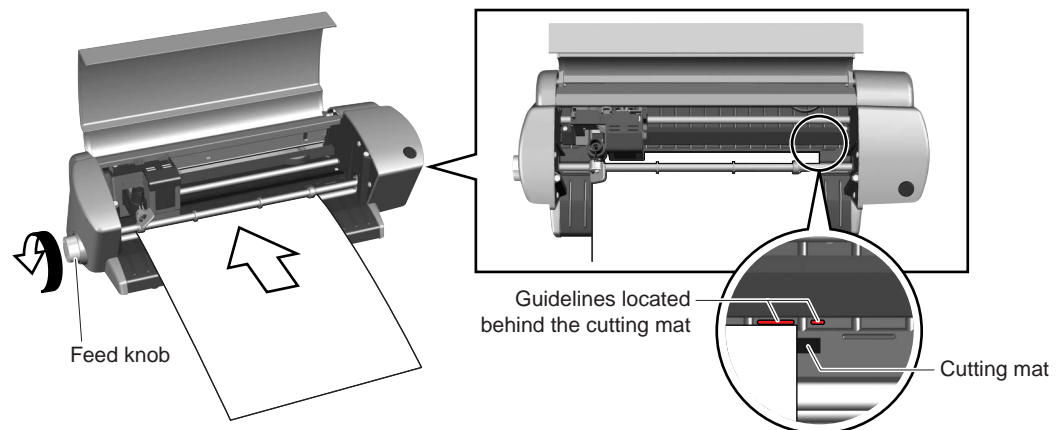

Allowable cutting area

Make sure that your design fits within the allowable cutting area. The allowable cutting area varies according to the size of the media and the mode you select.

If the media size is smaller than lette) size

Use the carrier sheet. (See Section 2.4, "Carrier Sheet".)

If the media is letter size

Standard mode: The width of the allowable cutting area is 7.4 inch.

Expanded mode: The width of the allowable cutting area is 7.8 inch.

If registration marks are used, the allowable width is 7.4 inch.

CHECKPOINT

- To change the mode from Standard to Expanded or vice versa, click "Properties" in the "Print" window and then select the desired mode in "Margin Settings" on the "Basic Settings" tab. The default setting is "Standard" mode.
- Align the left and right edges with the vertical guidelines, making sure that the sheet is straight.

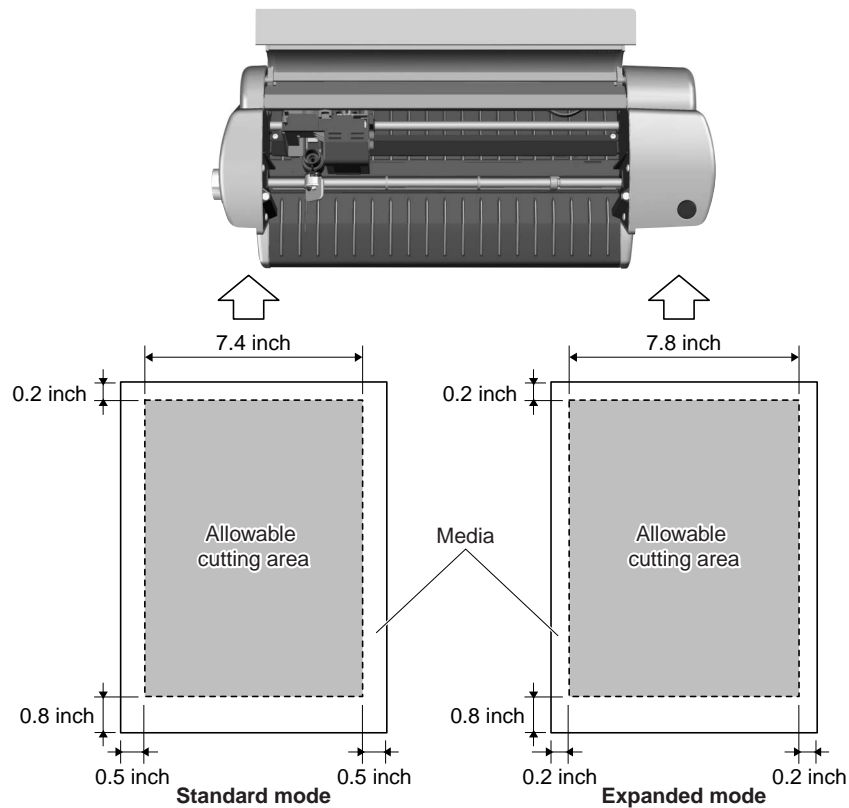

If the media width is between 8.5 and 10.25 inch

Even if the width of the sheet is larger than 8.5 inch, the allowable width is the same as that for an letter size sheet (7.7 inch in Standard mode and 7.8 inch in Expanded mode).

Standard mode: The width of the allowable cutting area is 7.4 inch.

Expanded mode: The width of the allowable cutting area is 7.8 inch.

If registration marks are used, the allowable width is 7.4 inch.

CHECKPOINT

- To change the mode from Standard to Expanded or vice versa, click "Properties" in the "Print" window and then select the desired mode in "Margin Settings" on the "Basic Settings" tab. The default setting is "Standard" mode.
- Align the left and right edges with the vertical guidelines, making sure that the sheet is straight.

If the media length is between 11 and 39 inch

Standard mode: The width of the allowable cutting area is 7.4 inch.

Expanded mode: The width of the allowable cutting area is 7.8 inch.

If registration marks are used, the allowable width is 7.4 inch.

CHECKPOINT

- To change the mode from Standard to Expanded or vice versa, click "Properties" in the "Print" window and then select the desired mode in "Margin Settings" on the "Basic Settings" tab. The default setting is "Standard" mode.
- Align the left and right edges with the vertical guidelines, making sure that the sheet is straight.

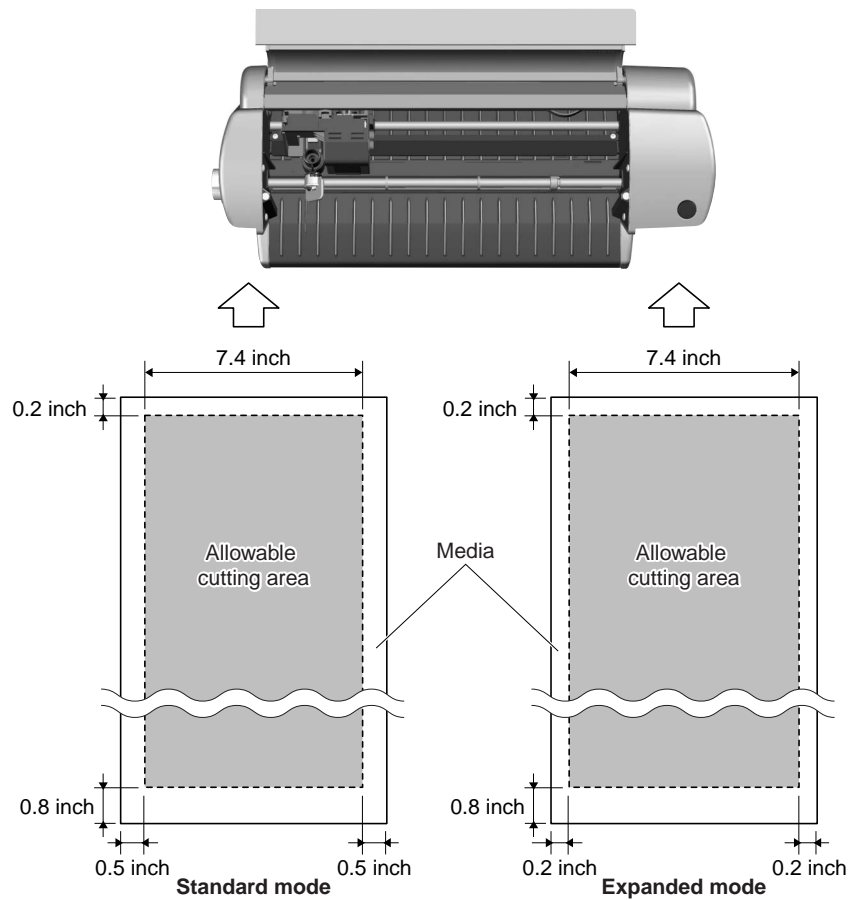

2.4 Carrier Sheet

Using the carrier sheet

The carrier sheet allows media smaller than letter size and media without a backing sheet (liner) to be cut.

CHECKPOINT

- Always be sure to use the carrier sheet when cutting right through media.
- The carrier sheet is reusable, and so it can be used repeatedly. When its adhesive power becomes weak, however, replace it with a new carrier sheet.
- The carrier sheet is a consumable. Replace it after cutting approximately 10 sheets. Using a carrier sheet for more than 10 sheets may cause misaligned cutting or other problems. Be sure to replace it with a new carrier sheet after cutting 10 sheets.
- Pulling on the carrier sheet to remove it from the Craft ROBO may shorten its lifetime or cause misaligned cutting. Be sure to use the feed knob to remove the media. (If you use the Eject Media function, the media will automatically be ejected to the front of the Craft ROBO after the cutting operation has been completed. For further details, please refer to the ROBO Master User's Manual.)

Using the carrier sheet for media with a width of 7.4 inch or smaller

CHECKPOINT

Do not use media smaller than postcard size (4 x 6 inch).

- (1) Peel off only the inside liner of the carrier sheet, so that the adhesive surface is visible. (Do not peel off the liner strips on both sides.)

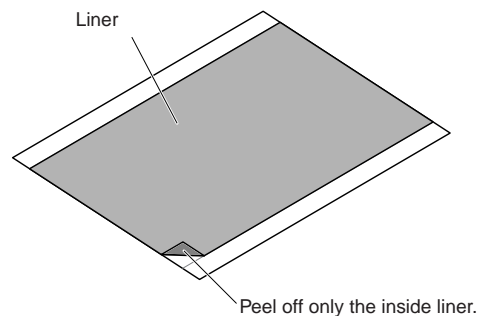

- (2) Press the media onto the adhesive surface of the carrier sheet.

CHECKPOINT

- When pressing the media onto the adhesive surface, be careful not to cause air bubbles or wrinkles in the media.
- Make sure that the edges of the media are parallel to the edges of the carrier sheet.

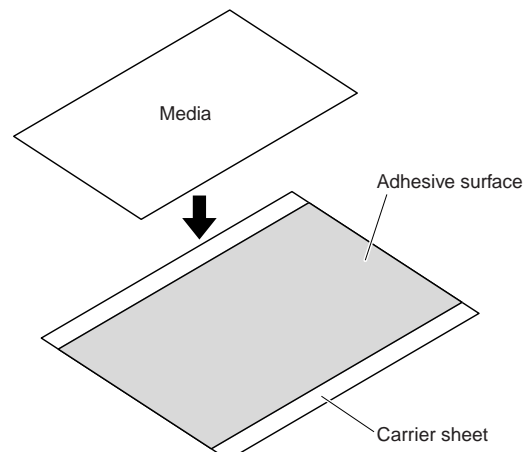

Using the carrier sheet for media from 7.5 to 8.5 inch in width (equivalent to letter size)

CHECKPOINT Do not use media that is wider than 8.5 inch with the carrier sheet.

- (1) Peel off the inside liner and the liner strips on both sides of the carrier sheet, so that the entire adhesive surface is visible.

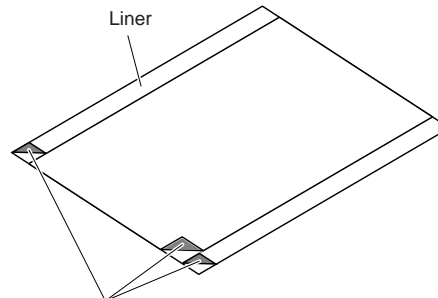

Peel off the inside liner and the liner strips on both sides of the carrier sheet.

- (2) Press the media onto the adhesive surface of the carrier sheet.

CHECKPOINT

- When pressing the media onto the adhesive surface, be careful not to cause air bubbles or wrinkles in the media.
- Make sure that all of the media is pressed down.
- Make sure that the edges of the media are parallel to the edges of the carrier sheet.

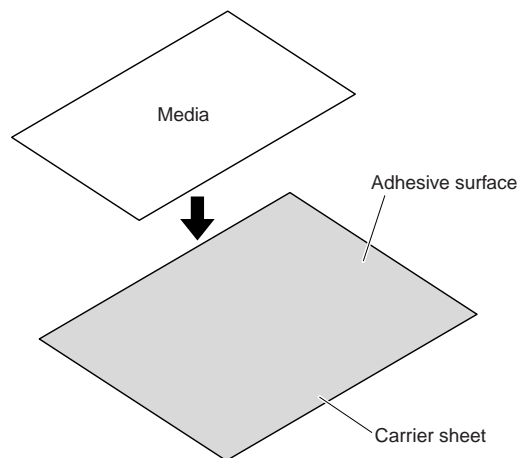

Allowable cutting area of the carrier sheet

The allowable cutting area of the carrier sheet is shown in the diagram below. When using media smaller than letter size, always affix the media within the allowable cutting area. In addition, make sure that the edges of the media are parallel to the edges of the carrier sheet.

CHECKPOINT Do not use media smaller than postcard size (4 x 6 inch).

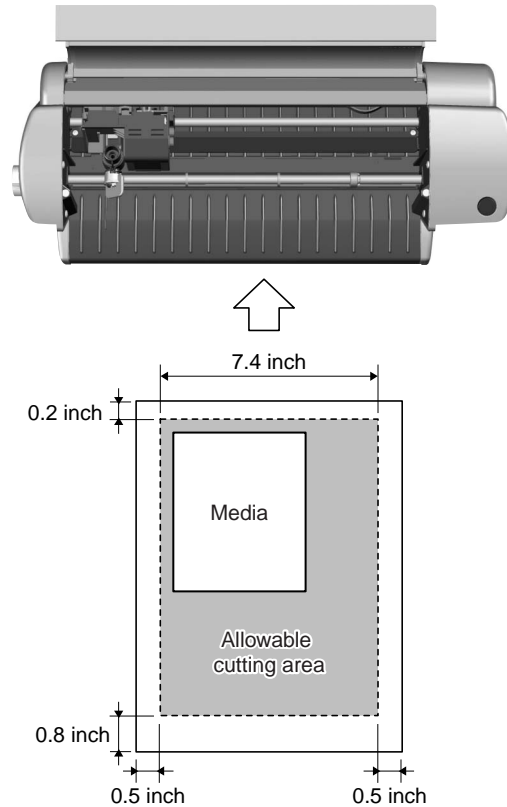

2.5 Adjusting and Mounting the Blade Holder

The blade adjustment cap controls the blade length. To obtain optimum cutting results, select the blade adjustment cap for the blade holder to suit the type of media to be cut.

Caution When handling the cutter blade, take care not to cut your hands.



Blade holder construction

The blade holder consists of a holder to which a cap containing a blade is attached. The length of the blade protruding from the cap can be adjusted by selecting one of the three available blade adjustment caps.

Select the blade adjustment cap best suited for the media you plan to use.

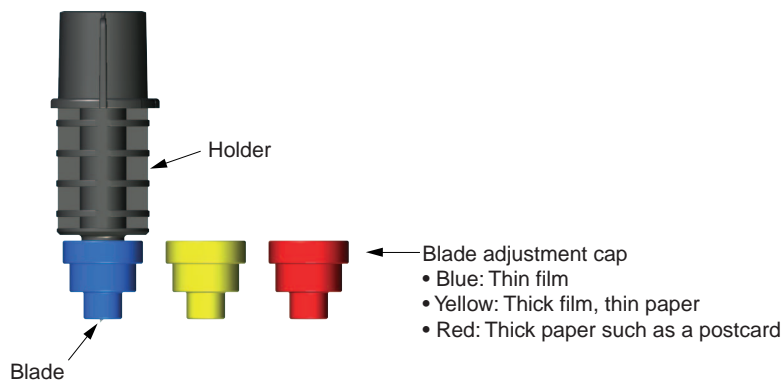

Blade adjustment caps and media selection

Select and attach the blade adjustment cap best suited to the media you plan to use. To prevent damage to the cutting mat, the length of the blade protruding from the cap should not exceed the thickness of the media.

Caution When handling the cutter blade, take care not to cut your hands.

Selection guide for blade adjustment caps

Cap	Media	Protruding blade length (approx.)
Blue	Thin film	0.1 mm
Yellow	Thick film, thin media	0.2 mm
Red	Thick media such as postcards	0.3 mm

Changing the blade adjustment cap

To prevent damage to the cutting mat, the length of the blade protruding from the cap should not exceed the thickness of the media.

⚠ Caution When handling the cutter blade, take care not to cut your hands.

The blade adjustment cap is a screw-on type.

- (1) Turn the cap in the counterclockwise direction to remove it.
- (2) Replace it with the correct blade adjustment cap.
- (3) Turn the cap in the clockwise direction to tighten it.

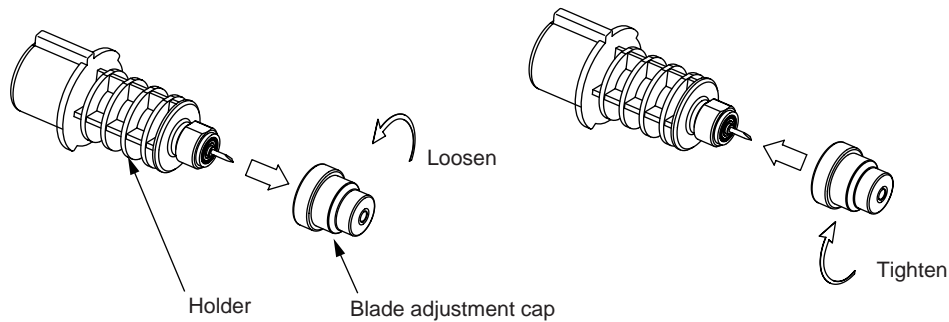

Assuming that the media thickness is " t ", as shown in the figure below, the blade length " l " should be equal to or slightly greater than " t ". Make sure that " l " is never greater than the combined thickness of the media and its backing sheet. If it is not possible to accurately determine the media thickness, perform a cutting test for each blade adjustment cap in the order of blue, yellow, and red. The most suitable cap is the one where only faint traces of the blade appear on the backing sheet after the cutting test has been performed.

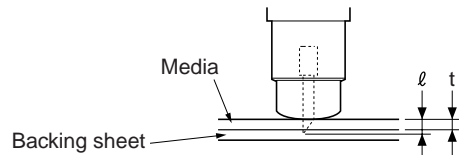

Mounting the blade holder

Mount the blade holder that has had its protruding blade length adjusted (by selecting the most suitable blade adjustment cap) in the Craft ROBO.

Caution When handling the cutter blade, take care not to cut your hands.

CHECKPOINT Be sure to grip the clamp bracket firmly when mounting or removing the blade holder.

- (1) Turn the lock lever to the left (OPEN direction) to loosen the clamp bracket.

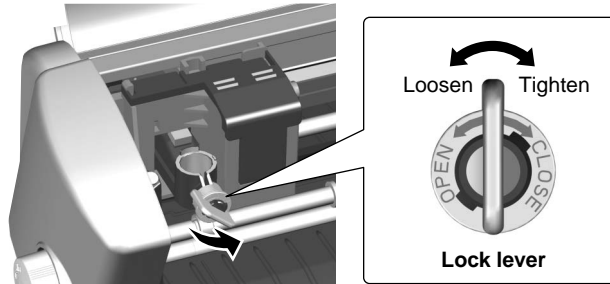

If you are using media that does not require the carrier sheet, mount the blade holder while making sure that the protrusion on the holder faces the front and that it is aligned with the notch in the clamp bracket.

If you are using the carrier sheet, turn the protrusion on the holder 90 degrees to the right so that it fits against the protrusion on the clamp bracket.

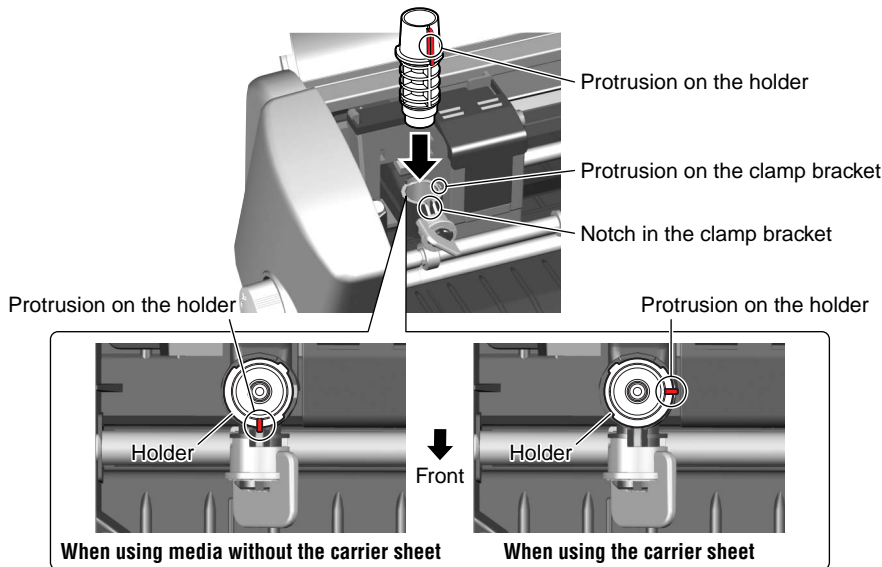

- (2) Firmly insert the blade holder in the clamp bracket and then turn the lock lever to the right (CLOSE direction) to tighten the clamp bracket.

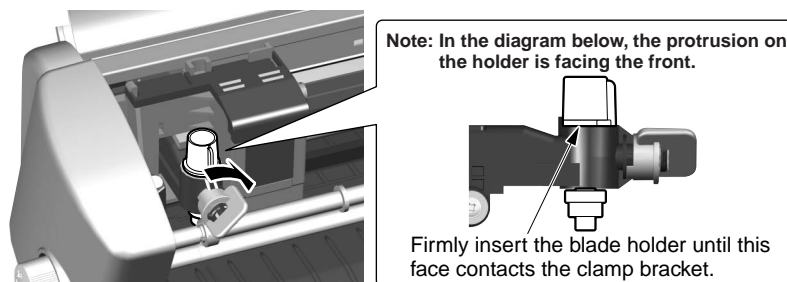

2.6 Mounting a ballpoint pen

Acceptable ballpoint pens

The ballpoint pen holder accepts the following pen types:

- (1) Cylindrical ballpoint pens: Up to 0.3 inch in diameter
- (2) Hexagonal ballpoint pens: Up to 0.2 inch side-to-side
- (3) The tips of both pen types must extend between 0.1 and 0.13 inch past the ballpoint pen holder's opening.

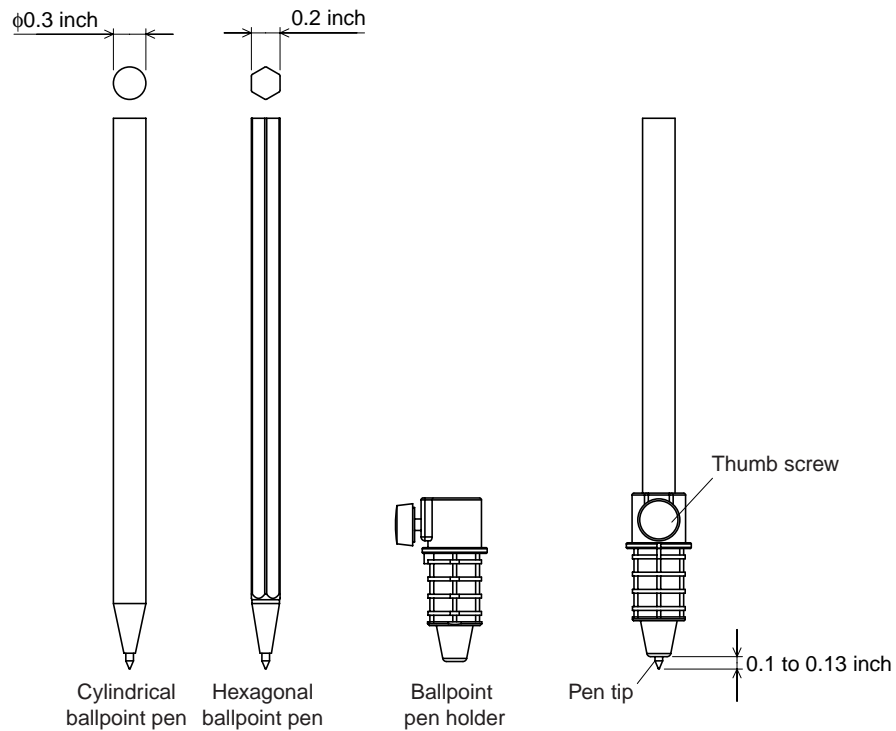

Mounting the ballpoint pen

Mount a ballpoint pen into the ballpoint pen holder and then mount the ballpoint pen holder in the Craft ROBO's clamp bracket.

CHECKPOINT When mounting the ballpoint pen holder, always align it with the notched part of the clamp bracket.

- (1) Loosen the thumbscrew on the ballpoint pen holder by turning it counterclockwise.
- (2) Insert the ballpoint pen into the holder.
- (3) Confirm that the tip of the ballpoint pen protrudes 0.1 - 0.13 inch from the holder.
- (4) Tighten the thumbscrew by turning it clockwise.
- (5) Turn the lock lever to the left (OPEN direction) to loosen the clamp bracket.
- (6) Mount the ballpoint pen holder in the clamp bracket while making sure that the protrusion on the holder faces the front and that it is aligned with the notch in the clamp bracket.

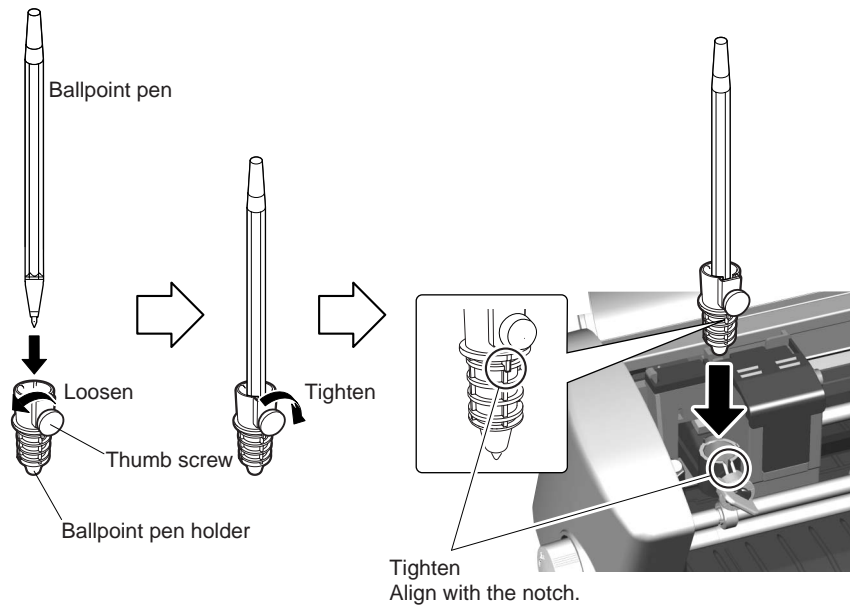

- (7) When the pen holder has been mounted, turn the lock lever to the right (CLOSE direction) to tighten it.

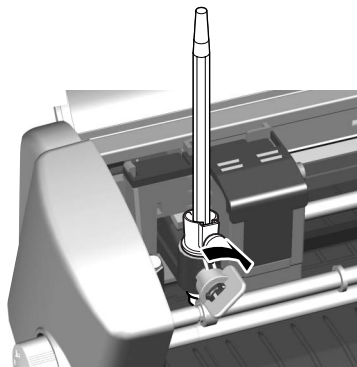

2.7 What to Do if This Happens

Thick or dense media like a photo paper may be cut when it is cut twice

- If you use "ROBO Master", CraftROBO cut media twice when you copy and paste the object at the same place on the ROBO Master.
- If you use "Cutting Master 2 for Craft ROBO", you can set how many times cut at "Passes" on Advanced Tab.

The blade no longer cuts cleanly

- If dirt or dust has adhered to the blade, remove the blade adjustment cap and then remove any dirt from around the blade.
- Start up the Craft ROBO Controller, select the "Adjust Settings" check box, and then increase the value by one in the "Thickness" direction.

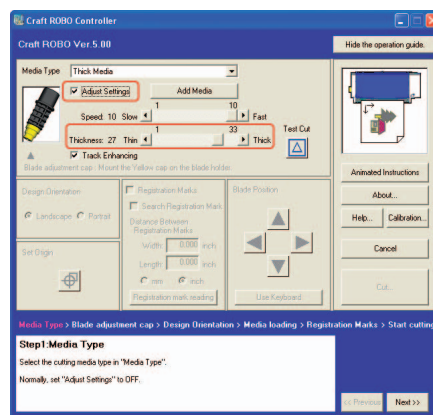

- Replace the cutter blade with a new one.
- Wipe the cutting head shaft with a lint-free cloth.

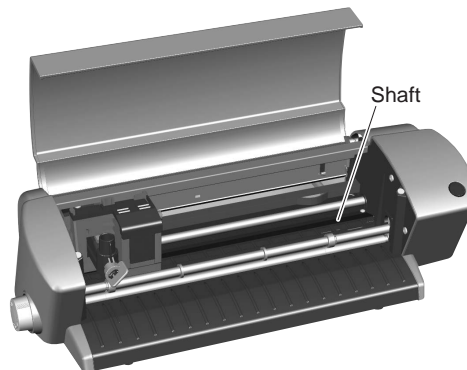

An abnormal noise is generated with the power is turned on, and the cutting head does not move smoothly.

- Wipe the cutting head shaft with a lint-free cloth.

CHAPTER 3. CRAFT ROBO CONTROLLER

The Craft ROBO Controller is a program that is used to perform all the basic settings such as selection of the Media Type and Craft ROBO operations such as test cutting.

CHECKPOINT

The term "media" as used in this manual refers to paper, film, and other materials to be cut or printed on.

3.1 System Requirements

The minimum system requirements to run the software are as follows.

- OS: Windows 2000 or Windows XP
- CPU: Pentium III 600 MHz or better
- Memory: 128 MB minimum (256 MB recommended)
- Monitor: Must be capable of 1024 x 768 High Color display (True Color recommended)
- Mouse
- CD-ROM drive

3.2 Installing the Craft ROBO Controller

This section describes how to install the software. Do not connect the Craft ROBO to your computer until instructed to do so by an on-screen prompt.

- Caution**
- Do not connect the Craft ROBO to your computer until instructed to do so by an on-screen prompt.
 - If the Craft ROBO Controller has already been installed, select "Control Panel" → "Add or Remove Programs" and then uninstall the program before performing the setup operation.

Starting up the [Start] window

Insert the CD-ROM included with the Craft ROBO into your computer. The [Start] window shown below will be displayed. If this window is not displayed, open "My Computer" and double-click "CD Drive". If the "Start" window still does not appear, execute "MultiSetup.exe" included in the CD-ROM.



When the "Start" window opens, click "Install Craft ROBO Software and Driver" to display the "Setup Craft ROBO" window. Click the [OK] button to start up the installer of "ROBO Master", the software used for Print & Cut applications.

CHECKPOINT Be sure to close any open Windows applications before installing this software.

When the installer of ROBO Master is finished or cancelled, the installer of the Craft ROBO Controller will be started up.

Installing the Craft ROBO Controller

- When the installer starts up, the screen shown below is displayed first.

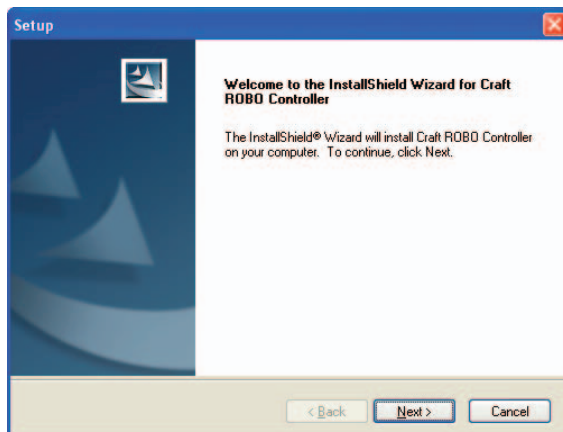

Click [Next] to proceed.

- (2) Next, a "Choose Destination Location" screen will be displayed.

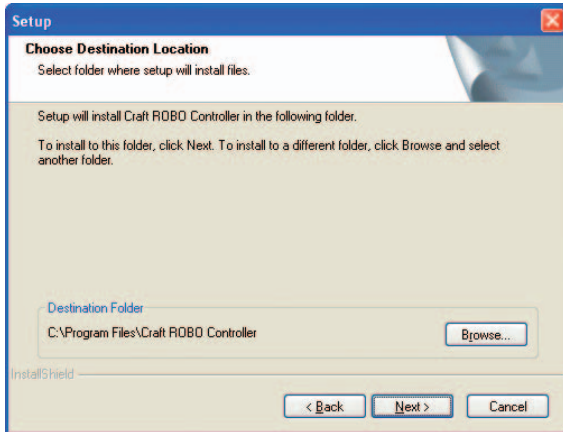

Select the folder in which the Controller is to be installed. Unless the folder shown by default does not have sufficient free space, it is normally not necessary to change it. If there is no need to change the default folder, click [Next] to proceed.

- (3) Next, a "Select Program Folder" screen will be displayed.

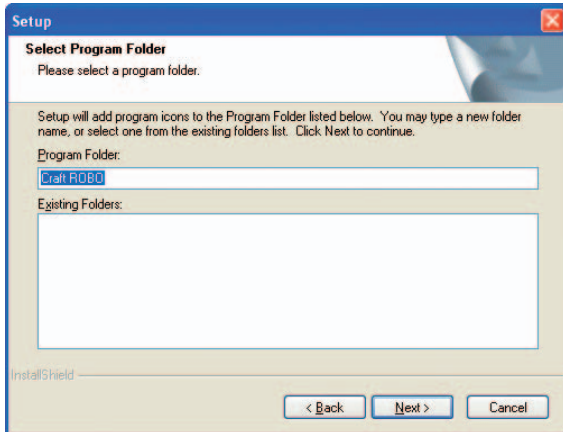

Select the program folder in which the program icon is to be placed. To place the program icon in a new folder, enter a new folder name in "Program Folders." To add the program icon to an existing folder, select one from the list of "Existing Folders." A new folder named "Craft ROBO" is prepared by default. If there is no need to change the default folder, click [Next]. File copying starts.

- (4) When the system has finished copying files, a "Setup Complete" screen is displayed indicating that installation is complete. Click [Finish] to complete the installation.

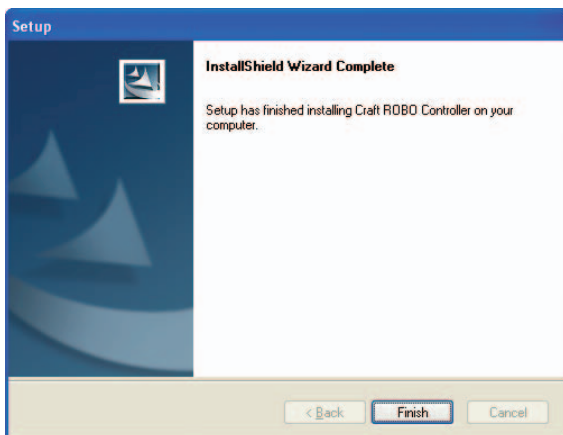

The system will then proceed to install the "Craft ROBO" driver. Follow the Help instructions displayed on the screen.

3.3 Starting up the Craft ROBO Controller

Press the Standby switch on the Craft ROBO to turn on the power, and check that the standby switch lamp is lit (blue).

Check that the Craft ROBO and your computer are connected by a USB cable.



The Craft ROBO Controller can be started up in either of the following two ways:

- (1) Starting up from the Windows [Start] menu
The Craft ROBO Controller can be started up from the Windows [Start] menu. To start it up, select "Start" → "(All) Programs" → "Craft ROBO" → "Craft ROBO Controller".
- (2) Starting up from Craft ROBO-compatible software (such as ROBO Master)
 - (a) Click [Craft ROBO] in the File menu of ROBO Master.

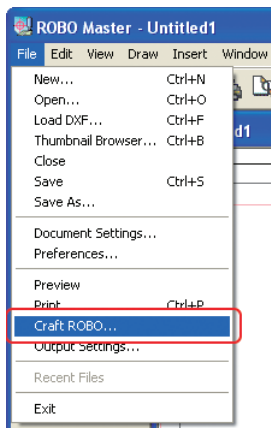

- (b) The "Output to Craft ROBO" window will open. Click [OK] to start up the Craft ROBO Controller. When the Craft ROBO Controller is started up from the ROBO Master software, the [Cut] button is displayed, enabling output from the Controller.

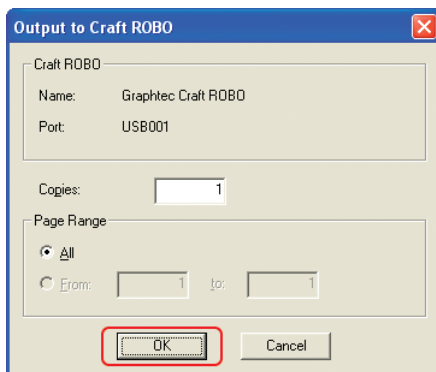

The above procedure is an example using the ROBO Master software. The Craft ROBO can also be started up from other compatible software applications. Please refer to the user's manual provided with each software application for the start-up procedure.

- (c) When the Craft ROBO software is started up, a window similar to the one shown below is displayed.

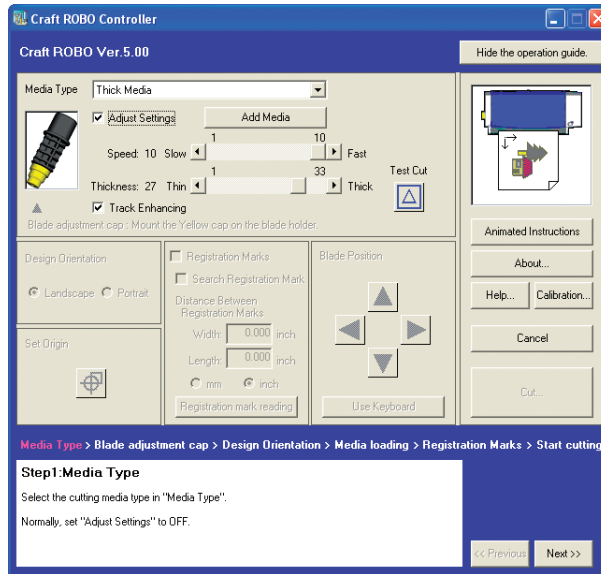

Caution

The Craft ROBO Controller settings may be performed automatically by the software that is used to start up the Controller. In this case, the parameters that can be selected may differ from those shown in the above window.

3.4 Craft ROBO Controller Operations

This section describes the Craft ROBO Controller's main functions and operating procedures.

Cutting your design

To perform cutting using the Craft ROBO, the sequence of operations shown below must be performed: [Create data (a design)] → [Make the cutline settings] → [Cut]

The [Create data (a design)] and [Make the cutline settings] operations are performed using Craft ROBO-compatible software such as ROBO Master.

When these operations have been completed, follow the steps below to cut out the design.

- (1) Turn on the power to the Craft ROBO, and check that the Standby switch lamp is lit (blue).
- (2) Start up the Craft ROBO Controller from Craft ROBO-compatible software such as ROBO Master. (See Section 3.3, "Starting up the Craft ROBO Controller".)
- (3) Select your media type from the "Media Type" drop-down box. (See "Media Type" in Section 3.5, "Craft ROBO Controller Settings".)
- (4) Replace the blade adjustment cap on the blade holder with a cap in the color that is displayed in the "Blade Adjustment Cap" indicator. (See "Blade Adjustment Cap" in Section 3.5, "Craft ROBO Controller Settings".)
- (5) Adjust the cutting conditions.
Select the "Adjust Settings" check box, and then perform test cutting to determine the optimum conditions by changing the "Speed", "Thickness", "Blade Adjustment Cap" and other settings. (See "Blade Adjustment Cap", "Adjust Settings", and "Test Cut" in Section 3.5, "Craft ROBO Controller Settings".)
- (6) Set the Design Orientation by referring to the illustration of the plotter in the upper right corner. (If the Controller is started up from ROBO Master, the Design Orientation is set automatically.) (See "Design Orientation" in Section 3.5.)
- (7) Load media in the Craft ROBO.
- (8) If required, change the origin by using the "Blade Position" and "Set Origin" buttons. (See "Blade Position" and "Set Origin" in Section 3.5, "Craft ROBO Controller Settings".)
- (9) Click the "Cut" button to start cutting. (See "Cut" in Section 3.5, "Craft ROBO Controller Settings".)
- (10) If cutting is not performed correctly, adjust the cutting conditions.
Select the "Adjust Settings" check box, and then perform test cutting to determine the optimum conditions by changing the "Speed", "Thickness", "Blade Adjustment Cap" and other settings. (See "Blade Adjustment Cap", "Adjust Settings", and "Test Cut" in Section 3.5, "Craft ROBO Controller Settings".)

Printing your design on a printer, and then using the Craft ROBO to cut it

To cut out a printed design using the Craft ROBO, the sequence of operations shown below must be followed: [Set Registration Marks] → [Create data (a design)] [Make the cutline settings] → [Print] → [Cut]

The [Set Registration Marks] ([Create data (a design)] ([Make the cutline settings] ([Print] operations are performed using Craft ROBO-compatible software such as ROBO Master.

When these operations have been completed, a design will have been printed together with registration marks. Follow the steps below to cut the design.

- (1) Turn on the power to the Craft ROBO, and check that the Standby switch lamp is lit (blue).
- (2) Start up the Craft ROBO Controller from Craft ROBO-compatible software such as ROBO Master. (See Section 3.3, "Starting up the Craft ROBO Controller".)

- (3) Select your media type from the "Media Type" drop-down box. (See "Media Type" in Section 3.5, "Craft ROBO Controller Settings".)
- (4) Replace the blade adjustment cap on the blade holder with a cap in the color that is displayed in the "Blade Adjustment Cap" indicator. (See "Blade Adjustment Cap" in Section 3.5, "Craft ROBO Controller Settings".)
- (5) Adjust the cutting conditions.
Select the "Adjust Settings" check box, and then perform test cutting to determine the optimum conditions by changing the "Speed", "Thickness", "Blade Adjustment Cap" and other settings. (See "Blade Adjustment Cap", "Adjust Settings", and "Test Cut" in Section 3.5, "Craft ROBO Controller Settings".)
- (6) Set the Design Orientation by referring to the illustration of the plotter in the upper right corner. (If the Controller is started up from ROBO Master, the Design Orientation is set automatically.) (See "Design Orientation" in Section 3.5.)
- (7) Load media in the Craft ROBO.
- (8) Check that the "Registration Marks" check box has been selected. (See "Registration Marks" in Section 3.5, "Craft ROBO Controller Settings".)
- (9) Click the "Cut" button to start cutting. (See "Cut" in Section 3.5, "Craft ROBO Controller Settings".)
- (10) If cutting is not performed correctly, adjust the cutting conditions.
Select the "Adjust Settings" check box, and then perform test cutting to determine the optimum conditions by changing the "Speed", "Thickness", "Blade Adjustment Cap" and other settings. (See "Blade Adjustment Cap", "Adjust Settings", and "Test Cut" in Section 3.5, "Craft ROBO Controller Settings".)

< The Search Marks function >

Two steps are required to read the registration marks.

- (a) The Craft ROBO searches for the first registration mark, which will become the reference registration mark, and makes it the origin point. (The first registration mark is the registration mark at the bottom left of the design. It is shown as a green square in the illustration of the plotter in the Craft ROBO Controller.
- (b) Using the first registration mark as the reference registration mark, the Craft ROBO checks the second and third registration marks.

Note: If the Craft ROBO failed to read the first registration mark in (a) above, the general registration mark position can be specified manually (see steps (11) to (13) below.

- (11) Deselect the "Registration Marks" check box, and then use the "Blade Position" function to move the pen to the position of the first registration mark (the registration mark at the bottom left of the design). It is shown as a green square in the illustration of the plotter in the Craft ROBO Controller. (See "Read Marks" in Section 3.5, "Craft ROBO Controller Settings".)
- (12) Click the "Read Marks" button to start manual reading of the registration marks. (See "Read Marks" in Section 3.5, "Craft ROBO Controller Settings".)
- (13) When the registration marks have been read correctly, click the "Cut" button to start cutting. (See "Cut" in Section 3.5, "Craft ROBO Controller Settings".)

Test Plotting

To reduce media waste, we recommend that you do a test plot when using cutting data for the first time or when you have changed the data. Test plotting allows you to visually confirm, by plotting the cutlines with a ballpoint pen, that the cutting data will be output correctly as the specified solid and folding lines.

- (1) Turn on the power to the Craft ROBO, and check that the Standby switch lamp is lit (blue).
- (2) Start up the Craft ROBO Controller from Craft ROBO-compatible software such as ROBO Master. (See Section 3.3, "Starting up the Craft ROBO Controller".)

- (3) Select your media type from the "Media Type" drop-down box. (See "Media Type" in Section 3.5, "Craft ROBO Controller Settings".)
- (4) Mount a commercially-available ballpoint pen in the provided ballpoint pen holder and then mount the pen holder in the Craft ROBO.
- (5) Set the Design Orientation by referring to the illustration of the plotter in the upper right corner. (If the Controller is started from ROBO Master, the Design Orientation is set automatically.) (See "Design Orientation" in Section 3.5.)
- (6) Load media in the Craft ROBO.
- (7) If required, change the origin by using the "Blade Position" and "Set Origin" buttons. (See "Blade Position" and "Set Origin" in Section 3.5, "Craft ROBO Controller Settings".)
- (8) Click the "Cut" button to start cutting. (See "Cut" in Section 3.5, "Craft ROBO Controller Settings".)

Performing a test cut and creating a Media Type setting

When creating a Media Type setting, the appropriate cutting conditions must be found by adjusting the media settings and performing a test cut.

- (1) Turn on the power to the Craft ROBO, and check that the Standby switch lamp is lit (blue).
- (2) Start up the Craft ROBO Controller from the Windows [Start] menu. (See Section 3.3, "Starting up the Craft ROBO Controller".)
- (3) Select your media type from the "Media Type" drop-down box. (See "Media Type" in Section 3.5, "Craft ROBO Controller Settings".)
- (4) Use the "Blade Position" function to move the blade to the position where you want to perform a test cut. (See "Blade Position" in Section 3.5, "Craft ROBO Controller Settings".)
- (5) Select the "Adjust Settings" check box, and then perform test cutting to determine the optimum conditions by changing the "Speed", "Thickness", "Blade Adjustment Cap" and other settings. (See "Blade Adjustment Cap", "Adjust Settings", and "Test Cut" in Section 3.5, "Craft ROBO Controller Settings".)
- (6) Click the "Add Media" button, specify the media name and the color of the blade adjustment cap, and then click the [OK] button. Your newly-created setting is added to the "Media Type" list. (See "Add Media" in Section 3.5, "Craft ROBO Controller Settings".)

3.5 Craft ROBO Controller Settings

When the Craft ROBO Controller is started up, the following screen appears.

When Craft ROBO-compatible software was used to start up the Controller

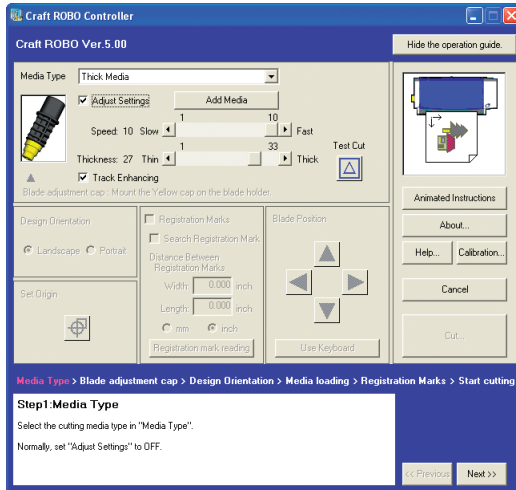

When the Windows [Start] menu was used to start up the Controller

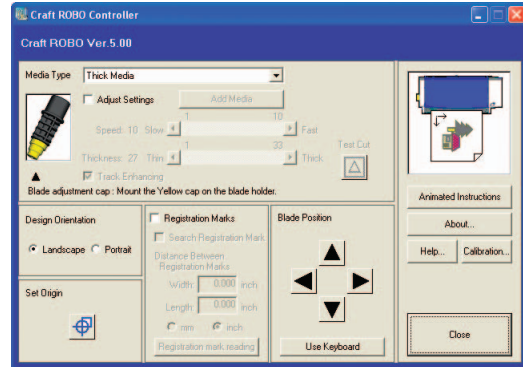

Hide/Show the operation guide

..... When the Craft ROBO Controller is started up, an operation guide is displayed at the bottom of the window. The [Hide/Show the operation guide] button turns the operation guide function on/off. Use the [Previous] and [Next] buttons provided within the operation guide to display the screens in succession and check the current settings for each parameter. Follow the step-by-step instructions for easy Craft ROBO setup and operation.

Animated Instructions .. Click to display animated instructions describing the operation of the "Craft ROBO" and the "Craft ROBO Controller".

About Click to display the version information of the Craft ROBO Controller currently in use.

Help Click to display Quick Help descriptions of the various Craft ROBO functions.

Cancel Click to exit the Craft ROBO Controller.

Cut Click to start cutting with the Craft ROBO. When the automatic reading of registration marks is specified, the registration marks are read first. When the registration marks have been read successfully, the Craft ROBO starts cutting.

Media Type Use this drop-down box to select the type of media to be cut.



The following 8 Media Type parameters are provided:

<Graphtec media>

- Card without Craft Paper Backing
- Card with Craft Paper Backing
- Vinyl Sticker
- Film Labels
- Magnetic Sheet



All of the above parameters are for media that is supplied by Graphtec. When using Graphtec-supplied media, be sure to select the correct parameter for the media that you are using. For further details on Graphtec-supplied media, please see the Graphtec web site.

<Other>

- Thick Media: Select this parameter when using Kent paper (inkjet, laser or similar paper).
- Thin Media: Select this parameter when using standard paper.
- Pen: Select this parameter when a ballpoint pen has been mounted in the Craft ROBO. The ballpoint pen is primarily used for test plotting before cutting.

Blade Adjustment Cap .. The Blade Adjustment Cap indicator shows the most suitable blade adjustment cap color for the media that has been selected from the "Media Type" drop-down box. Attach the blade attachment cap in the color shown to the blade holder before cutting that media.

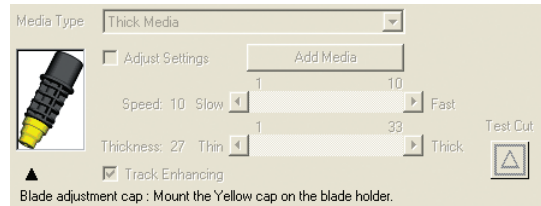

Only the tip of the blade protrudes from the blade holder. The blade adjustment cap color controls the blade length (the protruding length varies according to the color of the cap). The color selection is mostly determined by the thickness of the media to be cut.

Adjust Settings If the results of the test cutting indicate that the conditions need to be adjusted, select the "Adjust Settings" check box. As shown in the screen below, "Speed", "Thickness", "Test Cut" and "Add Media" are displayed. These parameters are disabled when the "Adjust Settings" box is not checked.

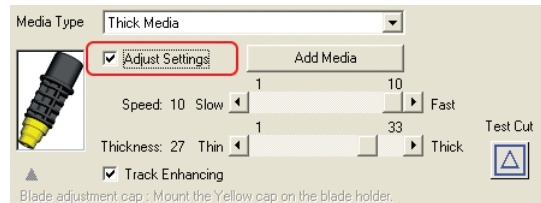

Speed Specifies the cutting speed.

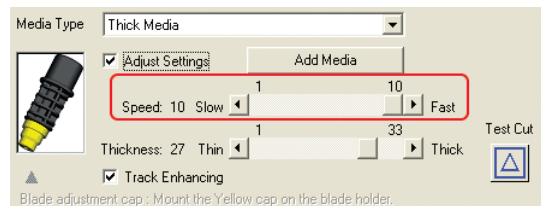

Selecting "Fast" increases the cutting speed, and selecting "Slow" reduces the speed. The slower the cutting speed, the higher the cutting quality. The speed can be adjusted in 10 steps.

Note: If a value of 31 or higher has been specified for "Thickness", the speed will be reduced in order to maintain an acceptable quality level.

Thickness Specifies the thickness of the media to be cut.

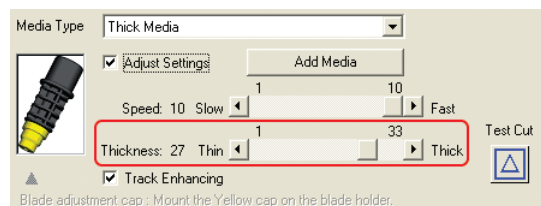

33 levels can be specified.

Note: If a value of 31 or higher has been specified for "Thickness", the speed will be reduced in order to maintain an acceptable quality level.

Track Enhancing Track enhancing refers to the action of moving the media back and forth several times before cutting is started to improve the quality of cutting. It is performed automatically when the thickness exceeds a certain value.

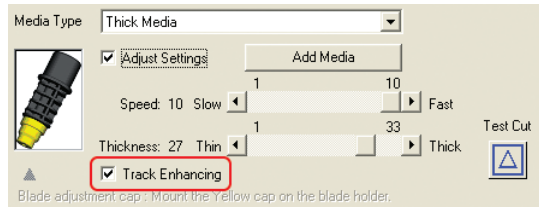

Keep this function on during normal use. If you need to shorten the cutting time, this function may be turned off provided you have verified that cutting is performed normally.

Test Cut Perform test cutting to check the cutting quality.

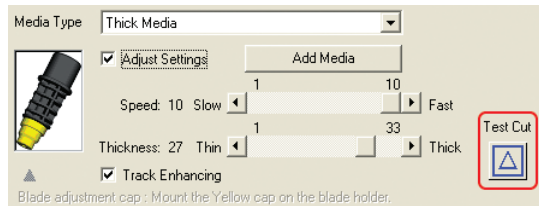

Use the [Blade Position] buttons to move the blade to the position at which test cutting is to be performed, and then click the [Test Cut] button. A 1cm x 1 cm test pattern will be cut. The cutting conditions are appropriate when the results of test cutting indicate that the media is cut cleanly with faint traces of the blade on the backing material (liner or carrier sheet). If cutting has not been performed correctly, such as when the backing material itself is cut or uncut areas of film remain, change the blade adjustment cap to one of a different color. Alternatively, change the "Media Type" parameter or change the "Thickness" setting.

CHECKPOINT

- The quality of the cutting results will vary, depending on the type of media to be cut and on other factors.
- If you plan to cut media that you have never used before, always be sure to perform test cutting first.

Add Media Click the "Add Media" button to open the "Add Media" window.

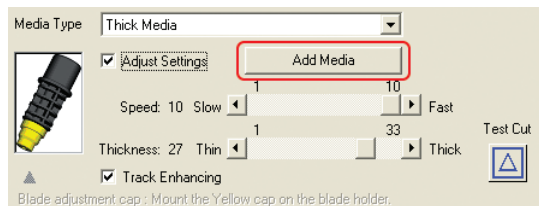

A custom media type can be created by entering its settings and name.

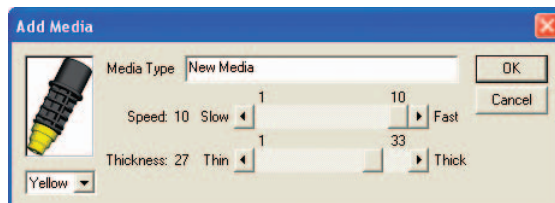

Blade Position Use these buttons to move the position of the blade or the pen (ballpoint pen) mounted in the Craft ROBO.

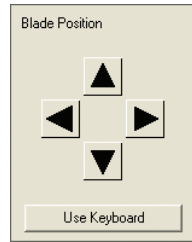

When the left-hand or right-hand buttons are pressed, the blade or the pen (ballpoint pen) is moved to the left or right. When the up or down buttons are pressed, the media is moved. Clicking the [Use Keyboard] button allows the arrow keys on the keyboard to be used in the same way as the [Blade Position] buttons.

Set Origin Use this button to specify the origin point of the cutting area.



After moving the blade or pen (ballpoint pen) to the desired origin point using the [Blade Position] buttons, click the [Set Origin] button to specify the current position as the origin. This function cannot be used (is not required) when registration marks are used for positioning.

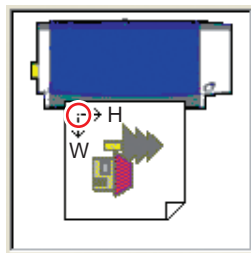

Landscape orientation

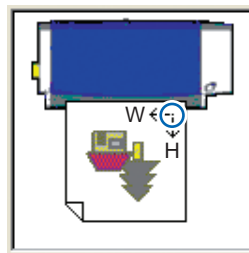

Portrait orientation

If the origin point has not been specified, and Landscape has been selected for the media orientation, the origin point is located in the vicinity of the red circle in the left-hand diagram. If Portrait has been selected for the media orientation, the origin point is located in the vicinity of the blue circle shown in the right-hand diagram.

CHECKPOINT

When moving the origin, be sure to take the size of the design to be cut into account. If the origin point is not set correctly, the part of the design that extends past the edges of the media as shown below will not be cut (or plotted).

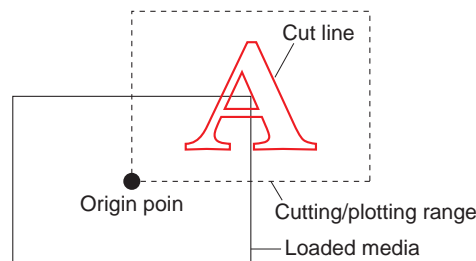

CHECKPOINT

The "Set Origin" function cannot be used when the "Registration Marks" check box has been selected.

Design Orientation Select "Landscape" for a design where the media is positioned horizontally and "Portrait" where the media is positioned vertically. The orientation is automatically set when output is performed from the ROBO Master.



If you change your selection, the illustration in the Craft ROBO Controller also changes.

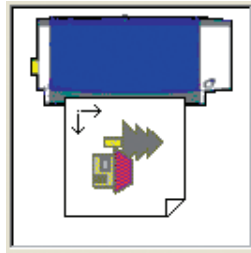

Landscape orientation

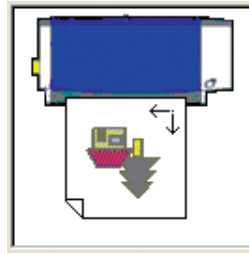

Portrait orientation

Registration Marks Select the "Registration Marks" check box when you want to cut a design that has been printed out on a printer.

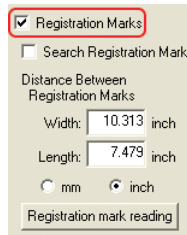

If ROBO Master was used to start up the Craft ROBO Controller, this parameter is automatically selected and cannot be changed. This setting is used for cutting a printed design that has registration marks already printed around it. When the "Registration Marks" check box is selected, the reading of registration marks is enabled.

Search Registration Marks

..... Search Marks is a function that automatically searches for registration marks within a fixed range from the current position of the blade/pen toward the center of the media.

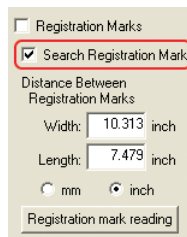

Keep this function on (check box selected) during normal use. When the Search Marks function is on, the registration marks are automatically searched for and read right before cutting. When the registration marks are read normally, cutting is performed.

The registration marks may not be automatically found if they are not located in the areas that are normally used for printing registration marks. In this case, deselect the Search Marks checkbox and perform manual reading of the registration marks. (See "Read Marks" in this section for details on how to perform manual reading of registration marks.)

Notes on Registration Marks

Registration marks are reference marks that are used to align the plotter's cutting position with an image that was printed out on a printer. Registration marks are printed along with the design, and the Craft ROBO reads them with its registration mark sensor to ensure alignment of the printed image and the cutline. The registration marks are shaped like the corners of a rectangle and are printed around the design at three of the four corners.

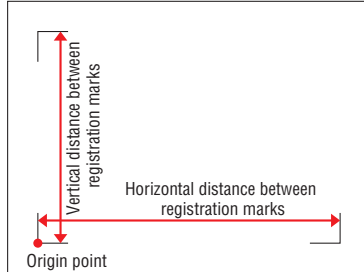

CHECKPOINT

- When registration marks are used, avoid placing them on or in the vicinity of the printed image wherever possible.
- When registration marks are used, we recommend that you use an inkjet printer. If a laser printer is used for output, the printed image may become distorted due to paper skew, and may cause misalignment of the cutting position.

Distance between Registration Marks

..... These controls are displayed when the "Search Marks" check box is not selected. The distance between the registration marks is the distance from the corner of one registration mark to the corner of the next registration mark.

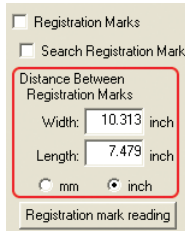

In most cases, the distances are set automatically from ROBO Master or an application that is able to perform this function. If ROBO Master was used to start up the Craft ROBO Controller, these settings are made automatically and cannot be changed.

Registration mark reading

..... This button is enabled when the "Search Marks" check box is not selected.

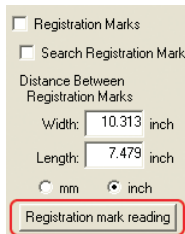

- (1) Use the [Blade Position] buttons to move the blade or pen (ballpoint pen) within the registration mark range. The registration mark range is displayed as a green square in the illustration at the upper right corner of the Controller. The position of the square may change based on the orientation of the design.

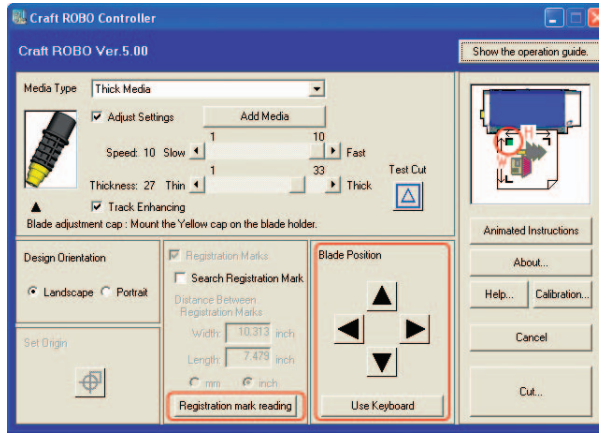

- (2) Click the Read Marks button to start manual reading of the registration marks.

Calibration Click this button to open the [Calibration] window.

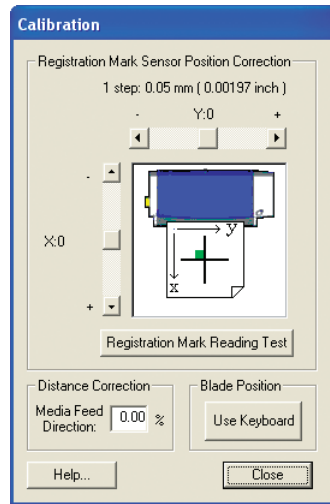

Registration Mark Sensor Position Correction

This function is used to adjust the cut position when the printed image and the cut position are misaligned. This operation enables the positions read by the registration mark sensor to be adjusted to the correct registration mark positions.

CHECKPOINT It is normally not necessary to perform this correction.

Follow the procedure described below to perform Registration Mark Sensor Position Correction.

- (1) Mount the blade holder in the Craft ROBO.
- (2) For the "Registration Mark Reading Test", use a sheet of paper with a cross drawn on it. Follow the procedure described below to prepare a sheet of paper with a cross drawn on it.

<If ROBO Master has been installed in your computer>

Print out the "Registration Mark Reading Test Sheet" that is provided with ROBO Master.

<If ROBO Master has not been installed in your computer>

Prepare a sheet of sheet of paper with a cross drawn on it to use for the "Registration Mark Reading Test", making sure that all the following conditions are met.

- The sheet must be white, non-glossy, letter size paper.
- Draw a cross with black lines 0.01 to 0.03 inch thick and at least 1.5 inch in length. The two lines must intersect each other at a right angle as shown below.

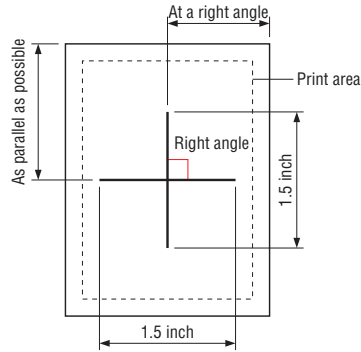

CHECKPOINT

Use a sheet of white, non-glossy, letter size paper for the Registration Mark Reading Test, and make sure that the blade holder is mounted in the Craft ROBO. Depending on the type of media that is being used, the registration mark may not be read correctly. Wherever possible, use a sheet of the actual media (paper, vinyl film) that you plan to use.

- (3) From the "Media Type" drop-down box of the Craft ROBO Controller, select the parameter that corresponds to the media used in the "Registration Mark Reading Test."
- (4) Load the "Registration Mark Reading Test Sheet" that you printed out from ROBO Master or the sheet that you prepared yourself for the "Registration Mark Reading Test" in the Craft ROBO. Next, open the "Calibration" window and move the blade to the green square part of the diagram. Click [Use Keyboard] in the "Blade Position" section of the Controller, and use the arrow keys on the keyboard to move the blade.

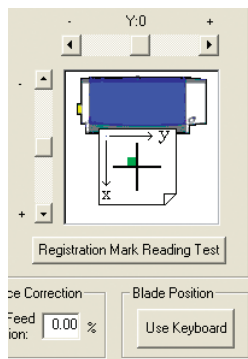

- (5) Click the [Registration Mark Reading Test] button. After the Craft ROBO has read the printed cross, it will use the mounted blade to draw a cross.

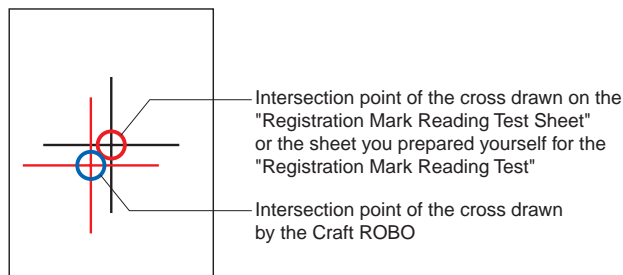

If the position of the intersection point recognized by the Craft ROBO is not aligned with that of the printed cross, correct it as specified below. Use the vertical (y) or horizontal (x) scroll bar to specify a correction value. The correction value must be in the range of -40 to 40. One step represents 0.002 inch. For example, if 20 is specified as the correction value, the line drawn by the pen (ballpoint pen) moves 0.04 inch.

If the position of the intersection point recognized by the Craft ROBO is not aligned with that of the printed cross, set a correction value in accordance with the figures shown below. The red circle in each diagram denotes the position of the intersection point recognized by the Craft ROBO.

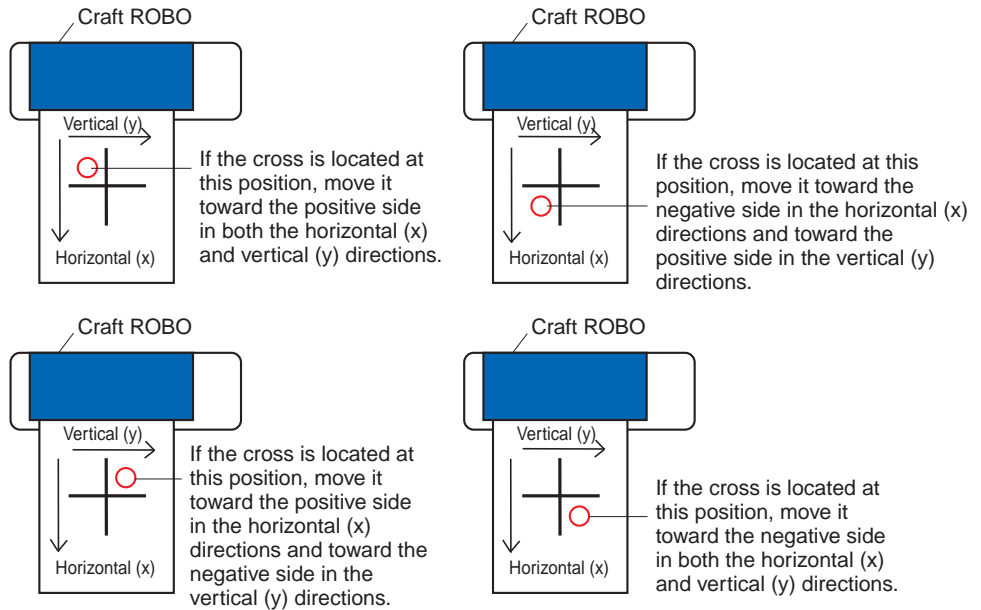

Distance Correction When the Craft ROBO moves the media, the distance by which the media is fed may not always be exactly as expected, depending on the media thickness and cutting speed. Distance Correction is used to account for such an error. In the range of -2% to +2%, enter a negative value if the fed distance is greater than the expected distance, or a positive value if the fed distance is less than the expected distance. The correction value may be calculated from the equation below.

$$\left(1 - \frac{\text{Actually moved distance}}{\text{Distance to be moved}} \right) \times 100 = \text{correction value}$$

Concrete example If the media needs to be moved 10 inch and the distance actually moved by the Craft ROBO is 9.9 inch, then

$$(1 - 9.9 \div 10) \times 100 = 1$$

Therefore, enter the value 1 for correction.

CHECKPOINT

It is not normally necessary to perform correction. When registration marks are used, correction is performed automatically.

Blade Position Clicking the [Use Keyboard] button allows the arrow keys on the keyboard to be used in the same way as the [Blade Position] buttons.

3.6 Error Messages

If any of the following error messages is displayed on your computer screen, follow the instructions that have been provided for each message.

The USB port is currently in use. Please wait ten seconds, and then try again.

→ Follow the instructions in the message.

Cannot communicate with the Craft ROBO. Check that the USB cable is connected correctly, press the Craft ROBO's standby switch, and then confirm that its lamp is lit (blue).

→ Follow the instructions in the message.

Craft ROBO communication error. Press the standby switch twice.

→ Follow the instructions in the message.

GITKUSBP.DLL could not be found, and so the Craft ROBO Controller could not be started. Please reboot your computer or re-install the Craft ROBO Controller.

→ Follow the instructions in the message.

To install the software again, first uninstall the Craft ROBO Controller currently installed. If the problem is not solved, download the latest version of the Craft ROBO Controller from the Craft ROBO website and install it.

The GITKUSBP.DLL functions could not be found, and so the Craft ROBO Controller could not be started. Please reboot your computer or re-install the Craft ROBO Controller.

→ Follow the instructions in the message.

To install the software again, first uninstall the Craft ROBO Controller currently installed. If the problem is not solved, download the latest version of the Craft ROBO Controller from the Craft ROBO website and install it.

The value specified for the horizontal (vertical) distance between the registration marks exceeds the specifiable range. Please specify a distance in the range X to X inch.

→ Follow the instructions in the message.

The value specified for the feed direction exceeds the specifiable range. Please specify a distance in the range of X to X %.

→ Follow the instructions in the message.

Registration mark reading failure. Please reload the medium.

→ Follow the instructions in the message.

Registration mark reading failed. Reload the media, and then click the [Cut] button once again. If the registration marks are still not read correctly, deselect the "Search Marks" check box, move the blade within the green square, and then click the "Read Marks" button.

→ Follow the instructions in the message.

The Craft ROBO Controller is already active. Please shut the controller down and perform the operation once again.

→ This message is displayed when you duplicate starting up the Craft ROBO Controller. Exit the currently operating Craft ROBO Controller and restart it to continue operation.

The design orientation has not been specified correctly. Please check the "Design Orientation" setting in your application program.

- Make the setting once again. If the problem is still not resolved, consult the manufacturer of the application software that you are using.

The distances between the registration marks have not been specified correctly. Please check the "Distance between Registration Marks" setting in your application program.

- Make the setting once again. If the problem is still not resolved, consult the manufacturer of the application software that you are using.

The specified Media Type cannot be used. Please specify a different Media Type.

- The default Media Type has been specified, or characters (Ä / : * ? < >) that cannot be used for the Media Type name have been specified. Please enter the Media Type name once again.

APPENDIX

Appendix A. Standard Specifications

Item	Specification
Feeding method	Grit-rolling
Drive	Stepping motor
Cutting range	Maximum: 7.8 x 39 inch (in expanded mode) Limited, however, to film media only (0.0039 inch or less in thickness, liner-included thickness of 0.012 inch or less)
Effective sheet width	Letter size supported Loadable sheet width: maximum 10.25 inch, minimum 8.5 inch unless the carrier sheet is used
Operating speed	0.39 - 3.9 inch per second (in 0.39 inch steps; 10 levels selectable)
Loadable number of blades/pens	1
Tools	Blade with dedicated blade holder General-purpose ballpoint pen (used only with the ballpoint pen holder)
Media types that can be cut	Film media 0.0039 inch or less in thickness, liner-included thickness of 0.012 inch or less (but excluding high-intensity reflective sheets), Kent paper (inkjet or laser paper up to 157 g/m ²), drawing paper, postcards, scrapbooking paper; inkjet photo paper * Not all types of media can be cut
Interface	USB 2.0 (Full speed)
Rated power supply	Dedicated adapter, +24 V DC (2.0 A)
Power consumption	28 W (10 W or less during standby)
Working environment	41 to 104°F, 35 to 80% R.H. (Non-condensing)
Guaranteed operating environment	61 to 90°F, 35 to 70% R.H. (Non-condensing)
External dimensions (W x D x H)	Approx. 15.6 x 6.3 x 4.4 inch (excluding protrusions)
Weight	Approx. 4.9 lbs

INDEX

A	
About	3-9
AC adapter	1-1
AC adapter jack	1-2
Add Media	3-11
Adjust Settings	3-10
Allowable cutting area	2-5
Carrier Sheet	2-9
Animated Instructions	3-9
B	
Ballpoint pen	
Acceptable	2-13
Mounting	2-14
Ballpoint pen holder	1-1
Blade adjustment cap	3-10
Changing	2-11
Blade adjustment caps and media selection	2-10
Blade holder	1-1
Construction	2-10
Mounting	2-12
Blade Position	3-12, 3-17
C	
Calibration	3-15
Cancel	3-9
Carrier Sheet	1-1, 2-7
Clamp bracket	1-2
Concrete example	3-17
Connecting and Turning on the Power	2-1
Connecting to a Computer	2-2
Copyright	i
Craft ROBO Controller	
Installing	3-2
Operations	3-6
Settings	3-9
Starting	3-4
System Requirements	3-1
Craft ROBO Software CD-ROM	1-1
Creating a Media Type setting	3-8
Cut	3-9
Cutting head	1-2
Cutting mat	1-2
Cutting your design	3-6
D	
Design Orientation	3-13
Distance between Registration Marks	3-14
Distance Correction	3-17
E	
Error Messages	3-18
F	
Federal Communications Commission	
Radio Frequency Interference Statement	i
Feed knob	1-2
Front guide	1-2
G	
Guideline	1-2
H	
Help	3-9
Hide/Show the operation guide	3-9
I	
Items	1-1
M	
Media loading method	2-3
Media rollers	1-2
Media Trial Kit	1-1
Media Type	3-9
N	
Notes on this Manual	i
P	
Parts and Functions	1-2
Performing a test cut	3-8
Pinch rollers	1-2
Power cable	1-1
PREFACE	i
Printing your design on a printer	
and then using the Craft ROBO to cut it	3-6
PRIOR TO USE	1-1
Q	
Quick Application Guide	1-1
Quick Start Instructions	1-1
R	
Registered Trademarks	i

Registration mark reading	3-14
Registration Mark Sensor Position Correction	3-15
Registration Marks	3-13, 3-14

S

Search Registration Marks	3-13
Set Origin	3-12
Standard Specifications	A-1
Standby switch	1-2
[Start] window	3-2

T

Test Cut	3-11
Test Plotting	3-7
Thickness	3-10
Track Enhancing	3-11

U

USB cable	1-1
USB interface connector	1-2

W

Warning	i
What to Do if This Happens	2-15

The specifications, etc., in this manual are subject to change without notice.

CC200i-UM-151

July 13, 2006 1st edition-01

GRAPHTEC CORPORATION

PREFACE

CH 1. PRIOR TO USE

CH 3. CRAFT ROBO CONTROLLER

INDEX

CONTENTS

CH 2. CONNECTION AND PREPARATION

Appendix A. Standard Specifications

GRAPHTEC CORPORATION

503-10 Shinano-cho, Totsuka-ku,
Yokohama 244-8503, Japan
Tel : +81(045)825-6250
Fax: +81(045)825-6396
Email : info@graphteccorp.com
Web : www.graphteccorp.com

Printed in Japan